

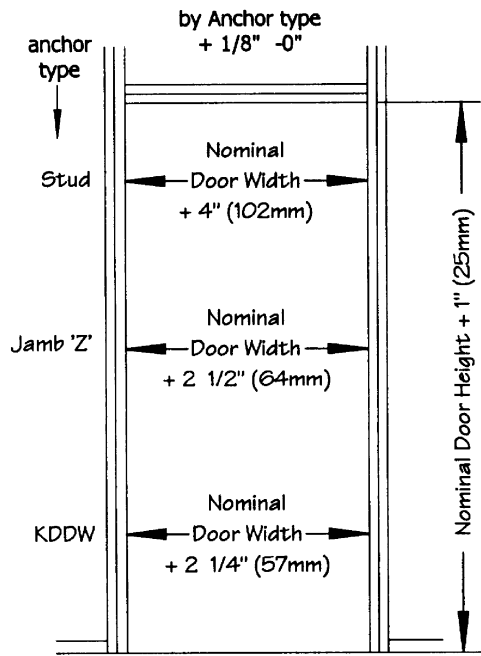

# Rough Stud Opening Dimensions

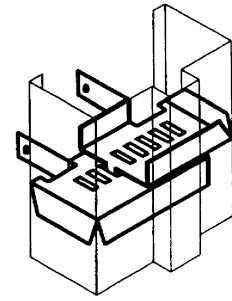

# Anchoring Systems

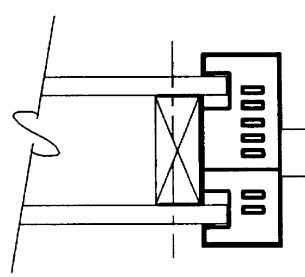

Metal or Wood Stud Anchor  
2 pc. style

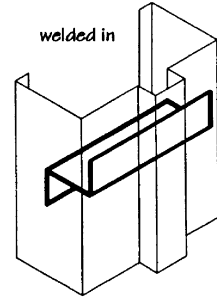
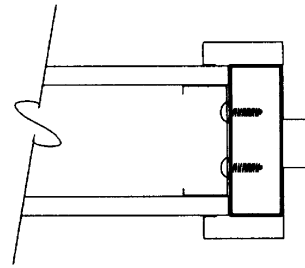

Jamb 'Z' Anchor

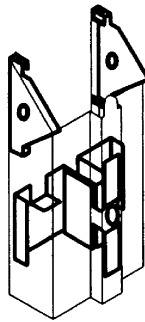
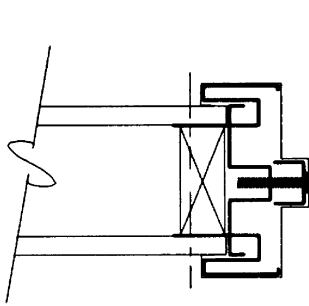

tension anchor

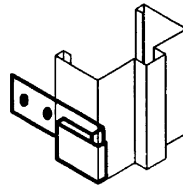

center anchor

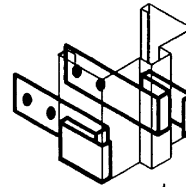

base anchor

KDDW with tension, center and bottom strap anchors

# Installation Instructions

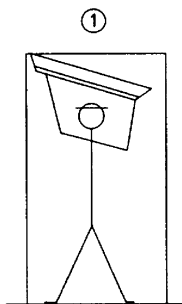

① Place head into position

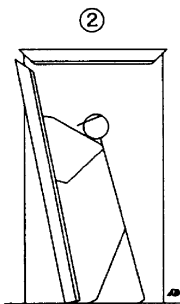

② Install hinge jamb. Fit mitre tabs into slots in head

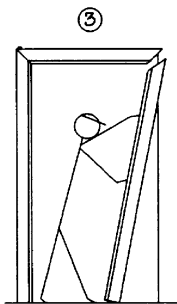

③ Install strike jamb. Fit mitre tabs into slots in head

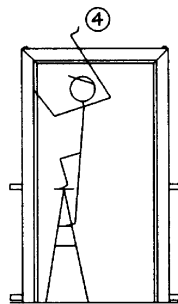

④ Adjust and secure head to jambs by bending mitre tabs towards wall

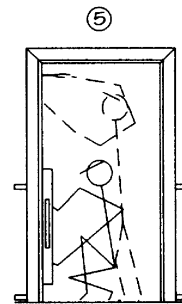

⑤ Plumb and square to nominal door dimensions. Use tension anchor if available

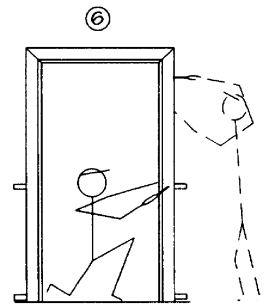

⑥ Anchor frame according to anchor type

Artek Door (1985) Limited is not responsible in any way for installation or any damage or liability resulting therefrom.



## Anchoring Details and Installation Instructions for 3 pc. Drywall Pressed Steel Frames

Artek Door (1985) Limited 225 Wycroft Rd. Oakville, Ontario, CANADA L6K 3S3

a Canadian manufacturer of standard and custom steel Doors and Frames

not to scale  
c:\detail\KDDW\install Rev 06 June 2000